

Surname	Centre Number	Candidate Number
Other Names		0

**GCSE**

4473/01

ADDITIONAL SCIENCE/PHYSICS**PHYSICS 2
FOUNDATION TIER**

P.M. MONDAY, 19 May 2014

1 hour

For Examiner's use only		
Question	Maximum Mark	Mark Awarded
1.	9	
2.	7	
3.	6	
4.	5	
5.	9	
6.	12	
7.	12	
Total	60	

ADDITIONAL MATERIALS

In addition to this paper you may require a calculator.

INSTRUCTIONS TO CANDIDATES

Use black ink or black ball-point pen. Do not use gel pen or correction fluid.

Write your name, centre number and candidate number in the spaces at the top of this page.

Answer **all** questions.

Write your answers in the spaces provided in this booklet.

If you run out of space, use the continuation page at the back of the booklet, taking care to number the question(s) correctly.

INFORMATION FOR CANDIDATES

The number of marks is given in brackets at the end of each question or part-question.

You are reminded of the necessity for good English and orderly presentation in your answers.

A list of equations is printed on page 2. In calculations you should show all your working.

You are reminded that assessment will take into account the quality of written communication (QWC) used in your answer to question 7(c).



M A Y 1 4 4 4 7 3 0 1 0 1

Equations

power = voltage \times current	$P = VI$
current = $\frac{\text{voltage}}{\text{resistance}}$	$I = \frac{V}{R}$
speed = $\frac{\text{distance}}{\text{time}}$	
acceleration [or deceleration] = $\frac{\text{change in velocity}}{\text{time}}$	$a = \frac{\Delta v}{t}$
acceleration = gradient of a velocity-time graph	
momentum = mass \times velocity	$p = mv$
resultant force = mass \times acceleration	$F = ma$
force = $\frac{\text{change in momentum}}{\text{time}}$	$F = \frac{\Delta p}{t}$
work = force \times distance	$W = Fd$

SI multipliers

Prefix	Multiplier	
m	10^{-3}	$\frac{1}{1000}$
k	10^3	1000
M	10^6	1000000





BLANK PAGE

**PLEASE DO NOT WRITE
ON THIS PAGE**

4473
010003



0 3

Answer all questions.

1. Study the circuit below and answer the questions that follow:

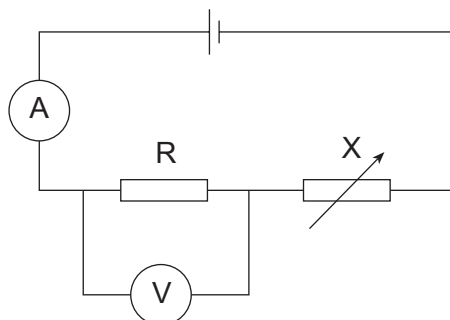

(a) Underline the word or phrase which correctly completes each sentence.

(i) The current through the resistor, R, is measured using an **(ammeter / voltmeter / resistor)** connected in **(single / series / parallel)**. [2]

(ii) The current through the resistor, R, is **(less than / the same as / more than)** the current through X. [1]

(iii) X is **(an ammeter / a voltmeter / a variable resistor)**. [1]

(b) The following measurements were taken from the meters in the circuit.

Voltage (V)	Current (A)
0.0	0.0
2.0	1.0
4.0	2.0
6.0	3.0
8.0	4.0
12.0	6.0



(i) Plot the data on the grid below and draw a suitable line.

[3]

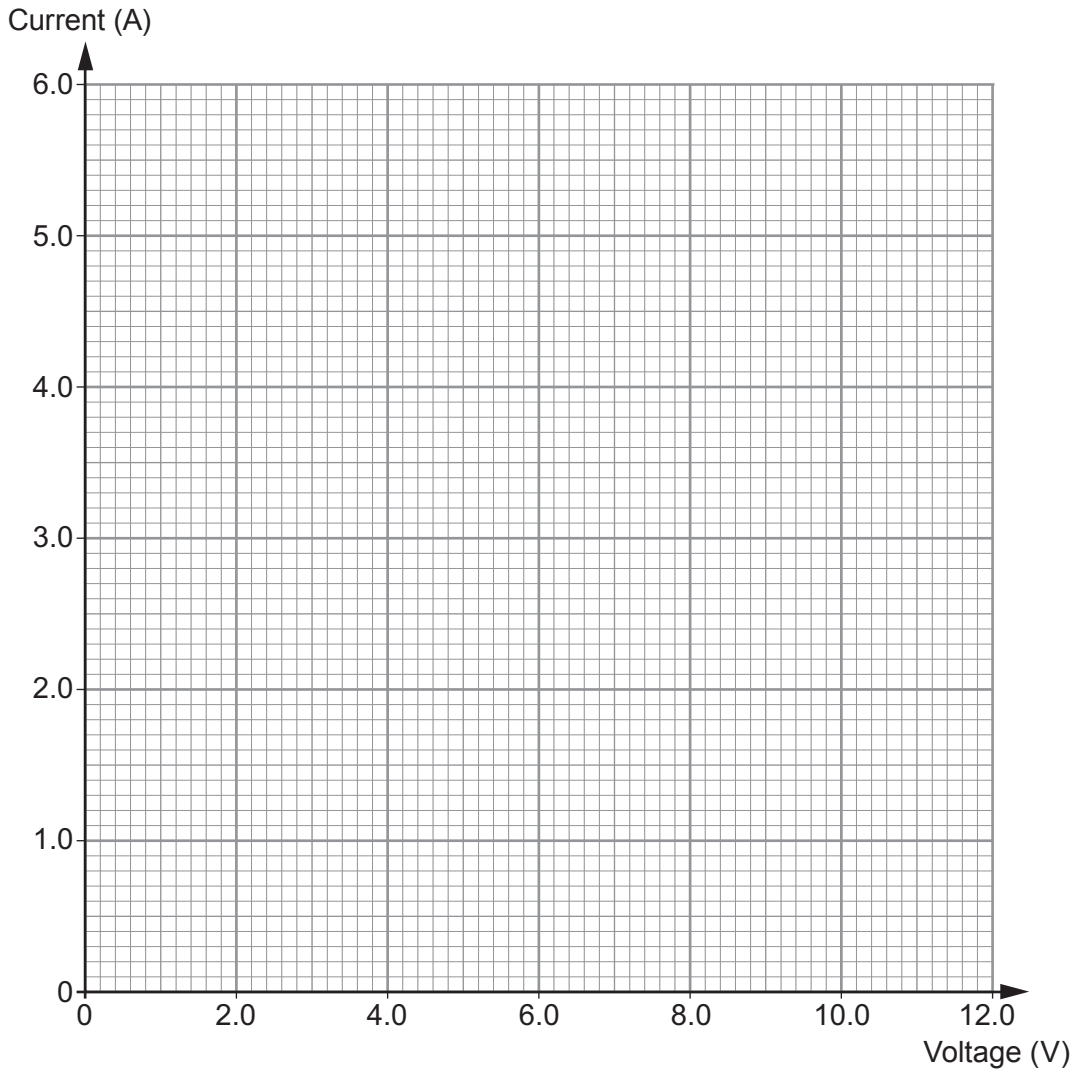

(ii) Use the graph and the equation:

$$\text{resistance} = \frac{\text{voltage}}{\text{current}}$$

to calculate the resistance of the resistor, R.

[2]

resistance = Ω

9

4473
010005



2. On 14 October 2012 Felix Baumgartner created a new world record when he jumped from a stationary balloon at a height of 39 km above the surface of the Earth. At 42 s of free fall he reached a terminal velocity of 373 m/s which is greater than the speed of sound.

- (a) Put a tick (✓) alongside the **three** correct statements below. [3]

Felix accelerated for the whole 39 km.

In the first 42 s his weight was greater than the air resistance.

In the first 42 s the air resistance was greater than his weight.

The speed of sound is less than 373 m/s.

In the first 42 s the air resistance decreased the further he fell.

During the fall, his inertia remained constant.

- (b) The mass of Felix and his suit was 100 kg.

Use the equation:

$$\text{momentum} = \text{mass} \times \text{velocity}$$

to calculate his momentum at terminal velocity. [2]

momentum = kg m/s

- (c) Use your answer from (b) and the equation:

$$\text{force} = \frac{\text{change in momentum}}{\text{time}}$$

to calculate the mean resultant force on him in the first 42 s. [2]

force = N



3. The mass of a sample of a radioactive isotope is 64 g and it has a count rate of 800 counts per minute. It is a gamma emitter.

It has a half-life of 30 minutes.

Radioactive decay follows the pattern below:

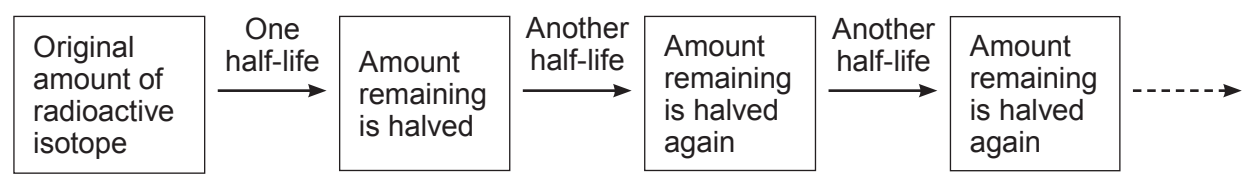

(a) (i) Find out how many half-lives it takes for the count rate to fall to 50 counts per minute. [1]

.....

(ii) How long does it take for the count rate to fall to 50 counts per minute? [2]

time =

unit

(iii) What mass of the radioactive isotope remains at this time? [1]

mass = g

(b) Explain why this radioactive isotope would be suitable as a radioactive tracer in medicine. [2]

.....
.....
.....

6



4.

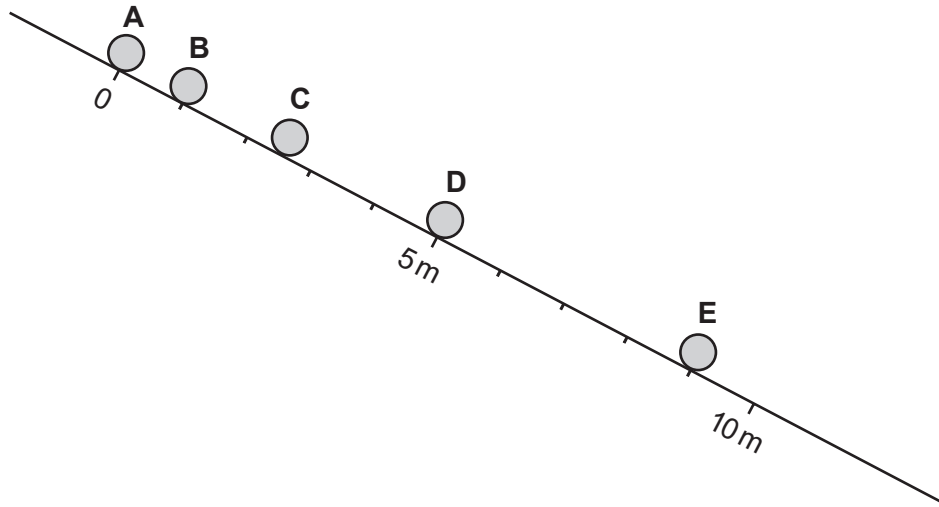

The diagram shows the positions of a ball at 0.5s intervals as it rolls down a 10m track. It took 0.5s to roll from **A** to **B**, then another 0.5s to roll from **B** to **C** and so on.

(a) (i) Write down the distance travelled by the ball from **A** to **E**. [1]

distance = m

(ii) Write down the time taken for the ball to travel from **A** to **E**. [1]

time = s

(b) Use the equation:

$$\text{speed} = \frac{\text{distance}}{\text{time}}$$

to calculate the mean speed as the ball rolled from **A** to **E**. [1]

speed = m/s



Examiner
only

(c) State how the diagram shows that the ball is accelerating as it moves. [1]

.....
.....

(d) Describe how the positions of the ball would be different if the track was less steep. [1]

.....
.....

5



Examiner only

5. The diagram below shows some of the forces acting on a car of mass 800kg. On Earth, the weight of 1 kg is 10N.

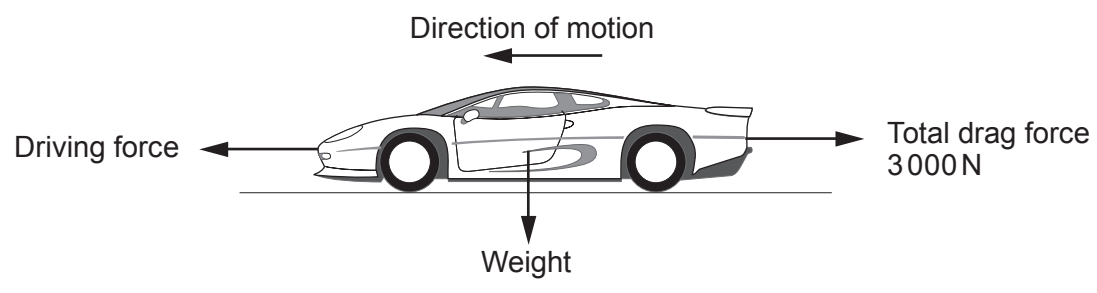

(a) (i) Describe the difference between the weight and the mass of the car. [2]

.....

.....

.....

(ii) Calculate the weight of the car. [1]

weight = N

(b) (i) The car is travelling at a **constant speed**. Write down the size of the driving force. [1]

driving force = N

(ii) The driving force is now increased to 4200N. Calculate the resultant horizontal force on the car. [1]

resultant force = N



Examiner
only

(iii) Use the equation:

$$\text{acceleration} = \frac{\text{resultant force}}{\text{mass}}$$

to calculate the acceleration of the car. [2]

acceleration = m/s²

(iv) Explain why the car will eventually reach a new higher constant speed when the driving force is increased to 4 200 N. [2]

.....

.....

.....

9



Examiner only

6. A car is moving at a speed of 15 m/s. A child runs out into the road causing the driver to make an emergency stop.
- (a) The graph shows how the speed of the car changes from the moment the driver sees the child.

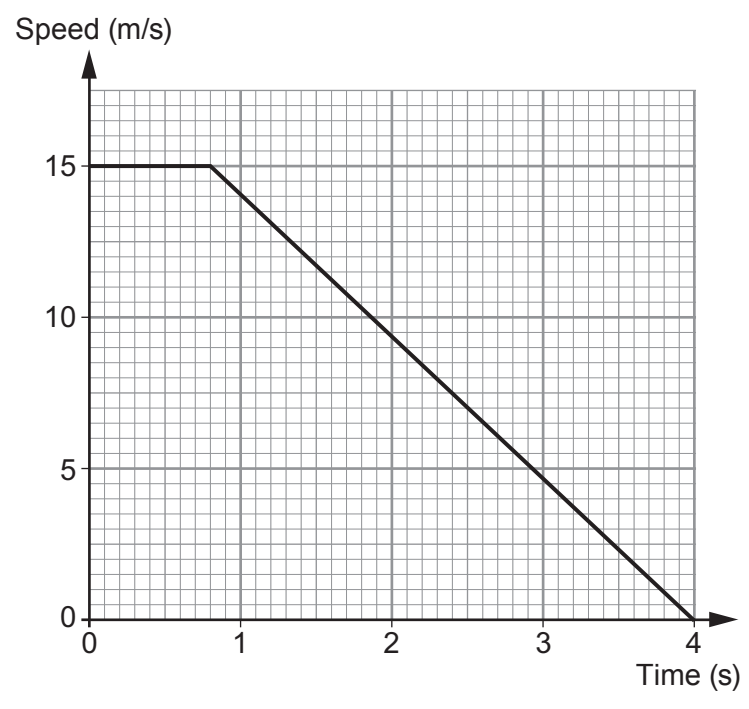

- (i) What was the reaction time of the driver? [1]
 s
- (ii) How long did it take the car to stop once the brakes were applied? [1]
 s
- (iii) Use an equation from page 2 to calculate the deceleration of the car. [2]

deceleration = m/s²

- (iv) Explain how the graph would be different for a driver who had drunk alcohol. [2]
-
-
-



Examiner only

(v) Explain how the graph would be different if it had been a wet day. [2]

.....

.....

.....

(b) In an emergency stop, the driver in the car moves forward before being stopped by the seat belt.

The graph shows the force exerted by the seat belt on the driver during the emergency stop.

Force exerted by seat belt (N)

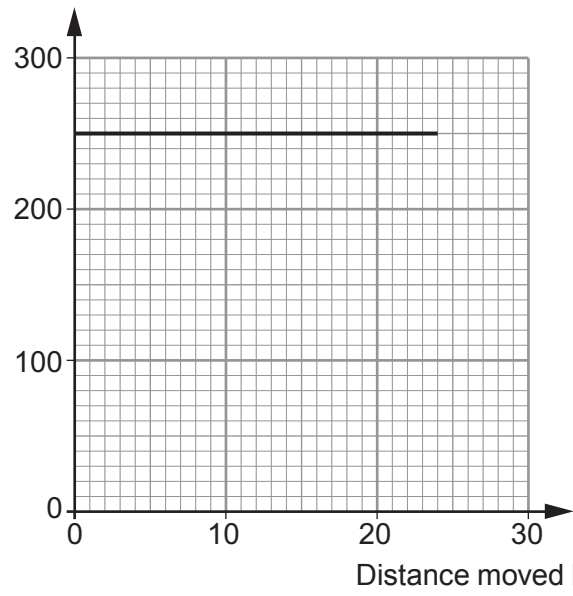

(i) Use an equation from page 2 to calculate the work done to stop the driver. [3]

work done = J

(ii) How much energy is transferred from the driver during the emergency stop? [1]

..... J

12



7. Nuclear fission and nuclear fusion are examples of nuclear reactions. Typical nuclear fission and nuclear fusion reactions are shown below.

(a) (i) Complete the equation for the first reaction. [2]



(ii) Explain how the first reaction could lead to an uncontrolled chain reaction. [2]

.....

.....

.....

(b) ${}_1^2\text{H}$ and ${}_1^3\text{H}$ are both isotopes of hydrogen.

Compare the structure of the **nuclei** of these two isotopes. [2]

.....

.....

.....



